

A6 package: 1200V 600A IGBT module

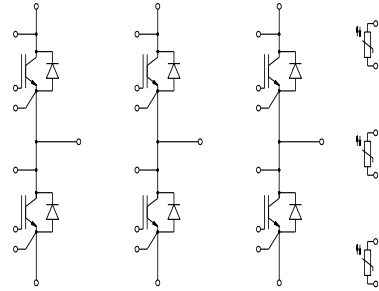
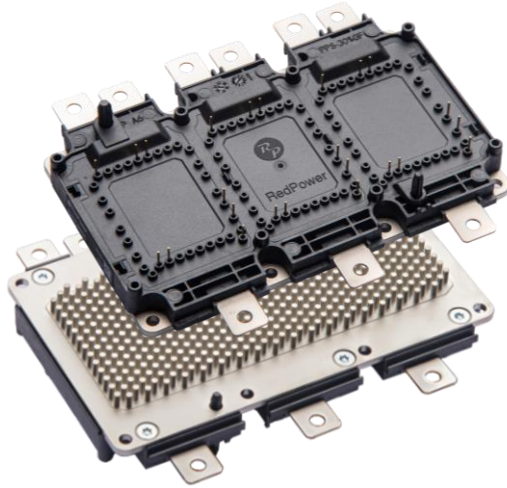

等效电路图  
Equivalent Circuit Schematic

**Features:**

- 1200V 600A,  $V_{CE(sat)} = 1.50V @ 25^{\circ}C$
- Direct cooled PinFin Base Plate
- Micro pattern trench/FS Technology
- Low switching losses

**产品特性:**

- 1200V 600A,  $V_{CE(sat)} = 1.50V @ 25^{\circ}C$
- PinFin 直接液冷散热底板
- 微沟槽栅/场终止技术
- 低开关损耗

**Typical Applications:**

- Electric Vehicles
- Motor Drives

**典型应用:**

- 电动汽车
- 电机驱动

**IGBT, Inverter / IGBT, 逆变部分**  
**Maximum Rated Values / 最大标称参数**

Collector-emitter voltage 集电极-发射极电压	$T_{vj}=25^{\circ}\text{C}$	$V_{CES}$	1200	V
Implemented collector current 连续集电极电流		$I_{C\text{ nom}}$	600	A
Continuous DC collector current 集电极连续直流电流	$T_F=65^{\circ}\text{C}, T_{vj\text{ max}}=175^{\circ}\text{C}$	$I_C$	550 <sup>1)</sup>	A
Repetitive peak collector current 集电极可重复峰值电流	$t_p=1\text{ms}$	$I_{CRM}$	1200 <sup>1)</sup>	A
Gate-emitter peak voltage 门极-发射极峰值电压		$V_{GES}$	$\pm 20$	V

**Characteristic Values / 性能参数**

			min.	typ.	max.		
Collector-emitter saturation voltage 集电极-发射极饱和压降	$I_C=450\text{A}, V_{GE}=15\text{V}$	$T_{vj}=25^{\circ}\text{C}$ $T_{vj}=125^{\circ}\text{C}$ $T_{vj}=150^{\circ}\text{C}$	$V_{CE\text{ sat}}$	1.50	1.70	V	
	$I_C=600\text{A}, V_{GE}=15\text{V}$	$T_{vj}=25^{\circ}\text{C}$ $T_{vj}=150^{\circ}\text{C}$		1.70	1.95		
Gate threshold voltage 门极阈值电压	$V_{CE}=V_{GE}, I_C=9\text{mA},$	$T_{vj}=25^{\circ}\text{C}$ $T_{vj}=150^{\circ}\text{C}$	$V_{GE\text{ th}}$	5.0	6.0 4.4	7.0	V
Internal gate resistor 内置门极电阻		$T_{vj}=25^{\circ}\text{C}$	$R_{G\text{ int}}$	0.43			$\Omega$
Input capacitance 输入电容	$V_{CE}=25\text{V}, V_{GE}=0\text{V}, f=100\text{kHz}, T_{vj}=25^{\circ}\text{C}$		$C_{ies}$	106			nF
Reverse transfer capacitance 反向传输电容	$V_{CE}=25\text{V}, V_{GE}=0\text{V}, f=100\text{kHz}, T_{vj}=25^{\circ}\text{C}$		$C_{res}$	0.39			nF
Gate charge 门极电荷	$V_{GE}=-15\text{V}\sim+15\text{V}, V_{CE}=600\text{V}$		$Q_G$	4.38			$\mu\text{C}$
Collector-emitter cutoff current 集电极-发射极关断漏电流	$V_{CE}=1200\text{V}, V_{GE}=0\text{V},$	$T_{vj}=25^{\circ}\text{C}$	$I_{CES}$			1	mA
Gate-emitter leakage current 门极-发射极漏电流	$V_{CE}=0\text{V}, V_{GE}=20\text{V},$	$T_{vj}=25^{\circ}\text{C}$	$I_{GES}$			500	nA
Turn-on delay time, inductive load 开通延迟时间, 感性负载	$I_C=600\text{A}, V_{CE}=600\text{V}$ $V_{GE}=-8\text{V}/15\text{V}$ $R_{Gon}=1.0\Omega$	$T_{vj}=25^{\circ}\text{C}$	$t_{don}$	182			ns
		$T_{vj}=125^{\circ}\text{C}$		190			
		$T_{vj}=150^{\circ}\text{C}$		192			
Rise time, inductive load 上升时间, 感性负载	$I_C=600\text{A}, V_{CE}=600\text{V}$ $V_{GE}=-8\text{V}/15\text{V}$ $R_{Gon}=1.0\Omega$	$T_{vj}=25^{\circ}\text{C}$	$t_r$	67			ns
		$T_{vj}=125^{\circ}\text{C}$		79			
		$T_{vj}=150^{\circ}\text{C}$		82			
Turn-off delay time, inductive load 关断延迟时间, 感性负载	$I_C=600\text{A}, V_{CE}=600\text{V}$ $V_{GE}=-8\text{V}/15\text{V}$ $R_{Goff}=5.0\Omega$	$T_{vj}=25^{\circ}\text{C}$	$t_{doff}$	792			ns
		$T_{vj}=125^{\circ}\text{C}$		832			
		$T_{vj}=150^{\circ}\text{C}$		842			
Fall time, inductive load 下降时间, 感性负载	$I_C=600\text{A}, V_{CE}=600\text{V}$ $V_{GE}=-8\text{V}/15\text{V}$ $R_{Goff}=5.0\Omega$	$T_{vj}=25^{\circ}\text{C}$	$t_f$	78			ns
		$T_{vj}=125^{\circ}\text{C}$		155			
		$T_{vj}=150^{\circ}\text{C}$		172			
Turn-on energy loss per pulse 开通损耗	$I_C=600\text{A}, V_{CE}=600\text{V}, L_s=30\text{nH}$ $V_{GE}=-8\text{V}/15\text{V}, R_{Gon}=1.0\Omega$ $di/dt(T_{vj}=25^{\circ}\text{C})=7200\text{A/us}$ $di/dt(T_{vj}=150^{\circ}\text{C})=5850\text{A/us}$	$T_{vj}=25^{\circ}\text{C}$	$E_{on}$	28.5			mJ
		$T_{vj}=125^{\circ}\text{C}$		40			
		$T_{vj}=150^{\circ}\text{C}$		43			
Turn-off energy loss per pulse 关断损耗	$I_C=600\text{A}, V_{CE}=600\text{V}, L_s=30\text{nH}$ $V_{GE}=-8\text{V}/15\text{V}, R_{Goff}=5.0\Omega$ $dv/dt(T_{vj}=25^{\circ}\text{C})=7350\text{V/us}$ $dv/dt(T_{vj}=150^{\circ}\text{C})=5950\text{V/us}$	$T_{vj}=25^{\circ}\text{C}$	$E_{off}$	51			mJ
		$T_{vj}=125^{\circ}\text{C}$		67			
		$T_{vj}=150^{\circ}\text{C}$		70.5			

<sup>1)</sup>非测试值, 设计计算所得

SC data 短路耐量	$V_{GE}=15V/-8V$ , $V_{CC}=600V$ , $V_{CEmax} \leq 1200V$	$t_p \leq 8\mu s, T_{vj}=25^\circ C$ $t_p \leq 6\mu s, T_{vj}=150^\circ C$	$I_{sc}$		3200 2600		A
Thermal resistance, junction to cooling fluid 结-冷却液热阻	Per IGBT, $\Delta V/\Delta t=10dm^3/min$ $T_F=25^\circ C$		$R_{thJF}$		0.089		K/W
Temperature under switching conditions 工作温度	$t_{op}$ continuous for 10s within a period of 30s, occurrence maximum 3000 times over lifetime		$T_{vj op}$	-40 150		150 175	$^\circ C$

### Diode, Inverter / 二极管, 逆变部分

#### Maximum Rated Values / 最大标称参数

Repetitive peak reverse voltage 可重复反向峰值电压	$T_{vj}=25^\circ C$	$V_{RRM}$	1200	V
Implemented forward current 连续正向电流		$I_{F nom}$	600	A
Repetitive peak forward current 可重复正向峰值电流	$t_p=1ms$	$I_{FRM}$	1200 <sup>1)</sup>	A

#### Characteristic Values / 性能参数

			min.	typ.	max.		
Forward voltage 正向通态压降	$I_F=450A, V_{GE}=0V$	$T_{vj}=25^\circ C$	$V_F$	1.95	2.40	V	
		$T_{vj}=125^\circ C$		1.93			
		$T_{vj}=150^\circ C$		1.92			
Peak reverse recovery current 反向恢复峰值电流	$I_F=600A, V_R=600V$ $-di_F/dt=6600A/\mu s(T_{vj}=150^\circ C)$ $V_{GE}=-8V$	$T_{vj}=25^\circ C$	$I_{RM}$	315		A	
		$T_{vj}=125^\circ C$		390			
		$T_{vj}=150^\circ C$		408			
Recovery charge 反向恢复电荷	$I_F=600A, V_R=600V$ $-di_F/dt=6600A/\mu s(T_{vj}=150^\circ C)$ $V_{GE}=-8V$	$T_{vj}=25^\circ C$	$Q_r$	17		$\mu C$	
		$T_{vj}=125^\circ C$		42			
		$T_{vj}=150^\circ C$		50			
Reverse recovery energy 反向恢复损耗	$I_F=600A, V_R=600V$ $-di_F/dt=6600A/\mu s(T_{vj}=150^\circ C)$ $V_{GE}=-8V$	$T_{vj}=25^\circ C$	$E_{rec}$	10.6		mJ	
		$T_{vj}=125^\circ C$		20.5			
		$T_{vj}=150^\circ C$		25.3			
Thermal resistance, junction to cooling fluid 结-冷却液热阻	Per FRD, $\Delta V/\Delta t=10dm^3/min$ $T_F=25^\circ C$		$R_{thJF}$		0.115		K/W
Temperature under switching conditions 工作温度	$t_{op}$ continuous for 10s within a period of 30s, occurrence maximum 3000 times over lifetime		$T_{vj op}$	-40 150		150 175	$^\circ C$

<sup>1)</sup> 非测试值, 设计计算所得

**NTC-Thermistor/ NTC-热敏电阻**
**Characteristic Values / 性能参数**

		min.	typ.	max.		
Rated resistance 标称电阻	$T_C=25^{\circ}\text{C}$	$R_{25}$	5.00			$\text{K}\Omega$
Deviation of R100 R100 偏移值	$T_C=100^{\circ}\text{C}$ , $R_{100}=493.3\Omega$	$\Delta R/R$	-5	5		%
Power dissipation 功率耗散	$T_C=25^{\circ}\text{C}$	$P_{25}$		20		mW
B-value B 值	$R_2=R_{25} \exp[B_{25/50}(1/T_2-1/(298.15\text{K}))]$	$B_{25/50}$	3375			K
B-value B 值	$R_2=R_{25} \exp[B_{25/80}(1/T_2-1/(298.15\text{K}))]$	$B_{25/80}$	3414			K
B-value B 值	$R_2=R_{25} \exp[B_{25/100}(1/T_2-1/(298.15\text{K}))]$	$B_{25/100}$	3436			K

**Module / 模块**

Isolation test voltage 绝缘测试电压	RMS, $f=50\text{Hz}$ , $t=1\text{min}$	$V_{\text{ISOL}}$	3.0			KV
Material of module baseplate 模块底板材料			Cu+Ni <sup>1)</sup>			
Internal isolation 内部绝缘			Si <sub>3</sub> N <sub>4</sub>			
Creepage distance 爬电距离	Terminal to heatsink Terminal to terminal	$d_{\text{Creep}}$	9.0 9.0			mm
Clearance 电气间隙	Terminal to heatsink Terminal to terminal	$d_{\text{Clear}}$	4.5 4.5			mm
Comparative tracking index 相对漏电起痕指数		CTI	200 <sup>2)</sup>			

min. typ. max.

Stray inductance module 模块杂散电感		$L_{\text{sCE}}$	9.5			nH
Module lead resistance, terminals-chip 模块引脚电阻, 端子-芯片	$T_C=25^{\circ}\text{C}$ , Per switch	$R_{\text{CC}'+\text{EE}'}$	0.75			mΩ
Storage temperature 贮存温度		$T_{\text{stg}}$	-40	125		$^{\circ}\text{C}$
Mounting torque for module mounting 模块安装力矩	Baseplate to heatsink, Screw M4	M	1.8	2.2		Nm
	Terminal connection, Screw M5		3.6	4.4		
	PCB to frame		0.5	0.6		
Weight 重量		G	715			g

1) 铜底板表面镀镍

2) CTI 约为 200

**Circuit Diagram / 曲线图**

**Output characteristic , Inverter IGBT (typical)**

输出特性, 逆变IGBT (典型)

$I_c=f(V_{CE})$ ,  $V_{GE}=15V$  (Inclusive  $R_{CC'+EE'}$ )

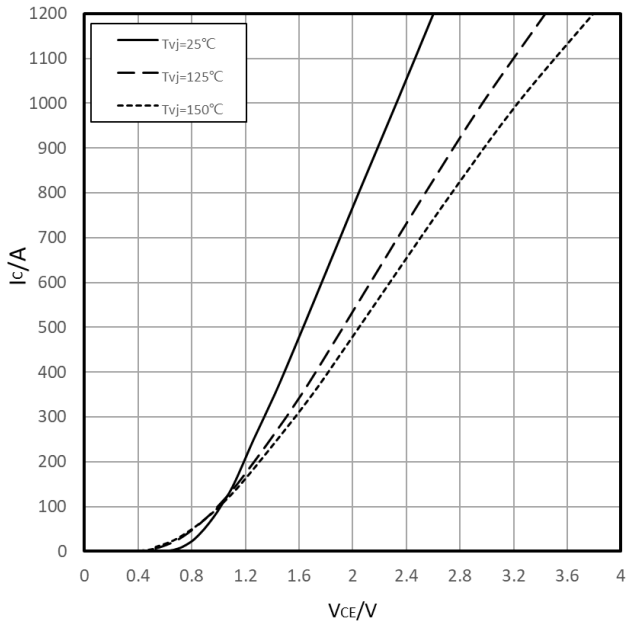

**Output characteristic , Inverter IGBT (typical)**

输出特性, 逆变IGBT (典型)

$I_c=f(V_{CE})$ ,  $T_{vj}=150^\circ C$

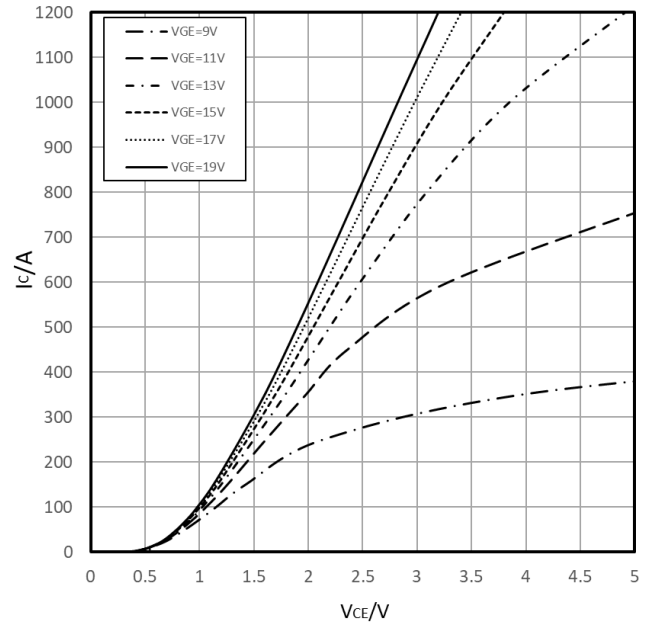

**Transfer characteristic , Inverter IGBT (typical)**

传输特性, 逆变IGBT (典型)

$I_c=f(V_{GE})$ ,  $V_{CE}=20V$

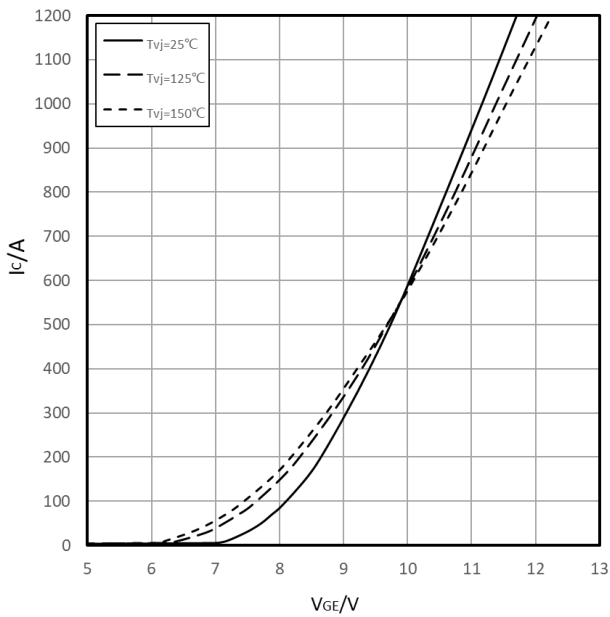

**Switching losses , Inverter IGBT (typical)**

开关损耗, 逆变IGBT (典型)

$E_{on}=f(I_c)$ ,  $E_{off}=f(I_c)$

$V_{GE}=+15V/-8V$ ,  $R_{gon}=1.0\Omega$ ,  $R_{goff}=5.0\Omega$ ,  $V_{CE}=600V$

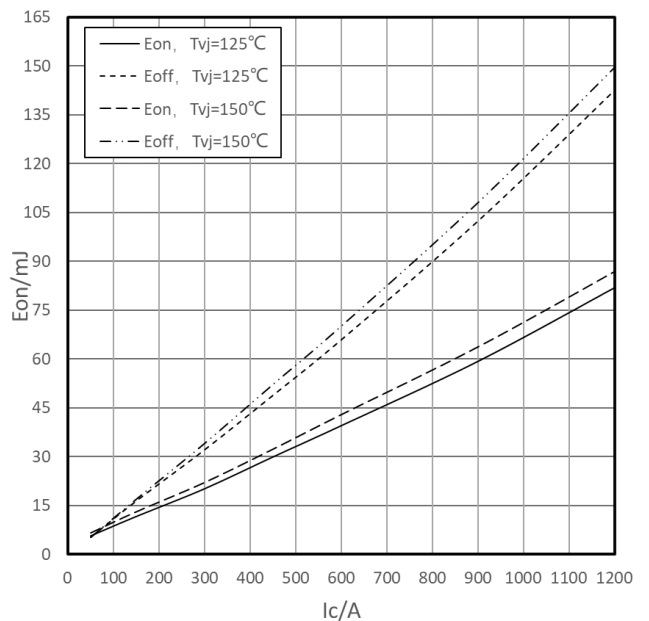

**Switching losses , Inverter IGBT (typical)**

开关损耗, 逆变IGBT (典型)

$E_{on}=f(R_g), E_{off}=f(R_g)$

$V_{GE}=+15V/-8V, I_C=600A, V_{CE}=600V$

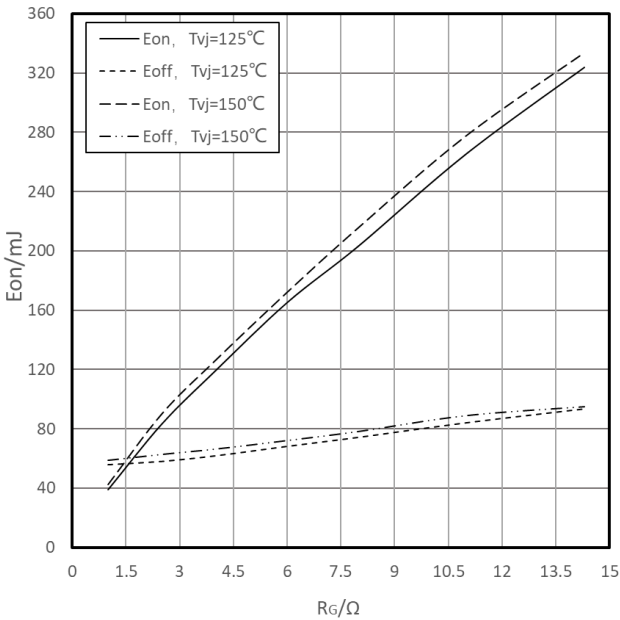

**Transient thermal impedance IGBT, Inverter**

瞬态热阻, 逆变IGBT

$Z_{th}=f(t)$

$\Delta V/\Delta t=10dm^3/min; T_f=25^\circ C; 100\% \text{ wafer}$

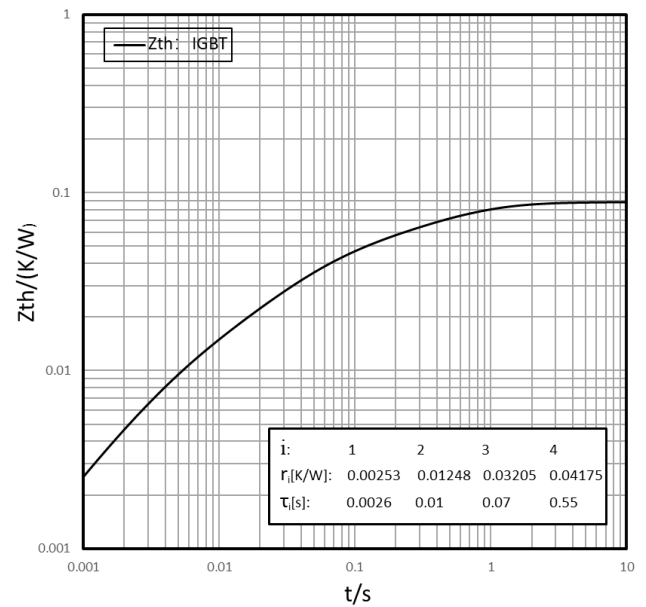

**Reverse bias safe operating area , Inverter IGBT (RBSOA)**

反偏安全工作区, 逆变IGBT (RBSOA)

$I_C=f(V_{CE}), V_{GE}=+15V/-8V, R_{goff}=5.0\Omega, T_{vj}=150^\circ C$

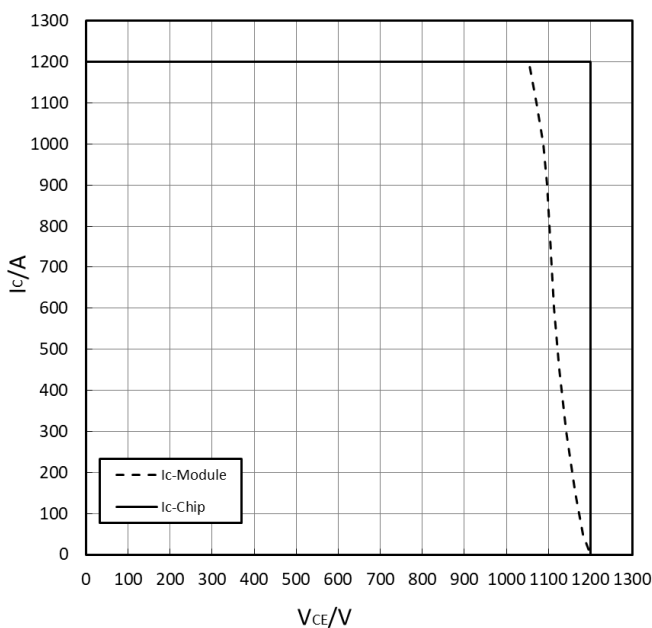

**Forward characteristic , Inverter FRD (typical)**

正向偏压特性, 逆变FRD (典型)

$I_F=f(V_F)$

(Inclusive  $R_{CC'+EE'}$ )

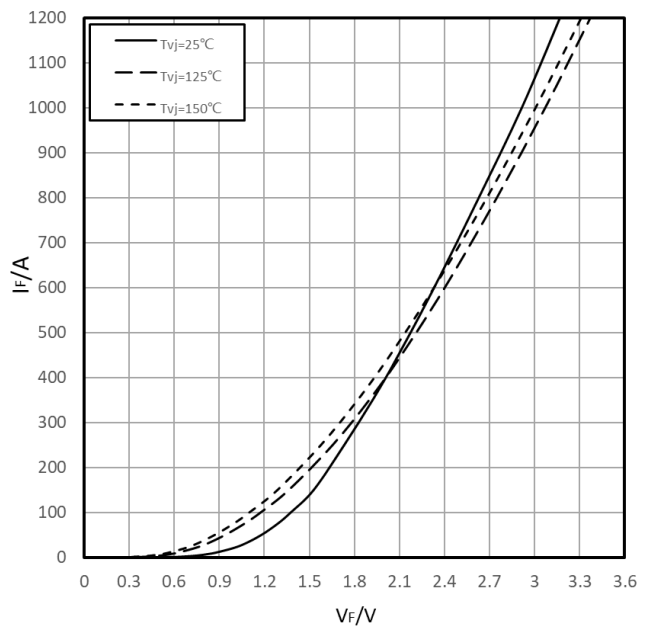

**Switching losses , Inverter IGBT (typical)**

开关损耗, 逆变FRD (典型)

$E_{rec}=f(I_F), R_{gon}=1.0\Omega, V_{CE}=600V$

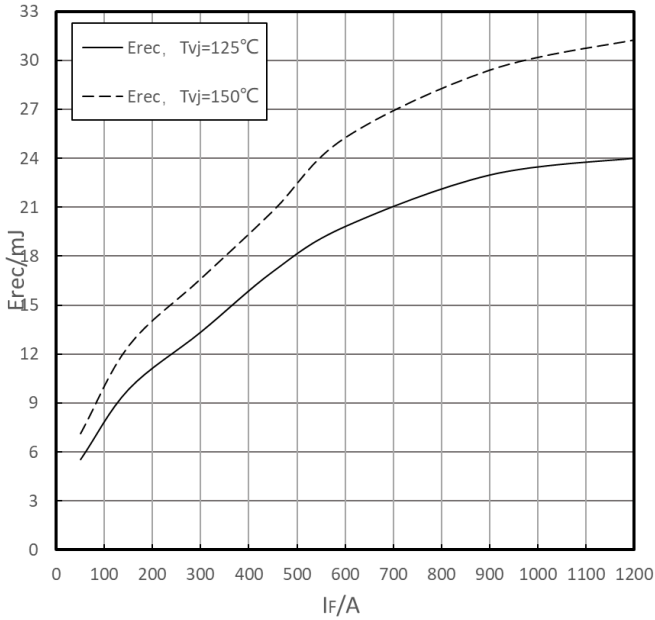

**Switching losses , Inverter FRD (typical)**

开关损耗, 逆变FRD (典型)

$E_{rec}=f(R_G), I_F=600A, V_{CE}=600V$

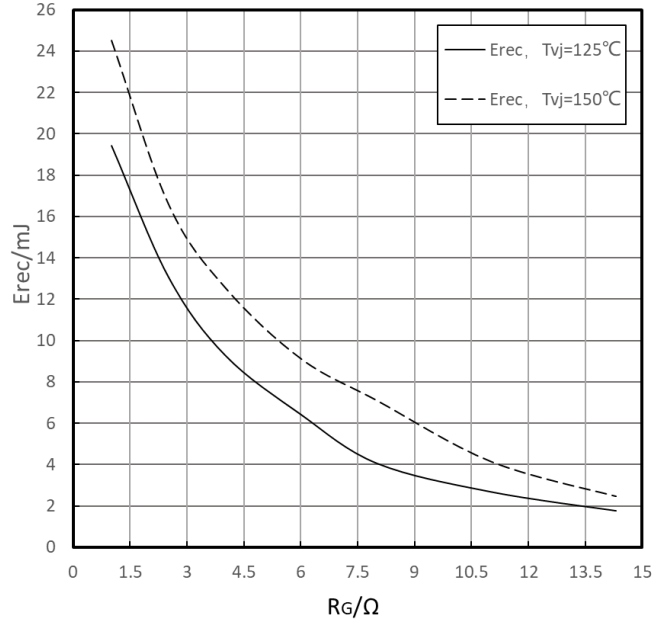

**Transient thermal impedance FRD, Inverter**

瞬态热阻, 逆变FRD

$Z_{th}=f(t)$

$\Delta V/\Delta t=10dm^3/min; T_f=25^\circ C; 100\% wafer$

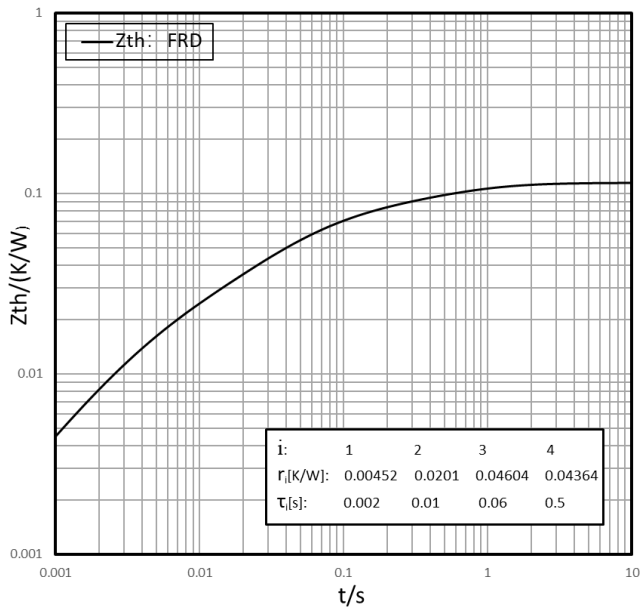

**NTC-Thermistor-temperature characteristic**

负温度系数热敏电阻 温度特性

$R=f(T)$

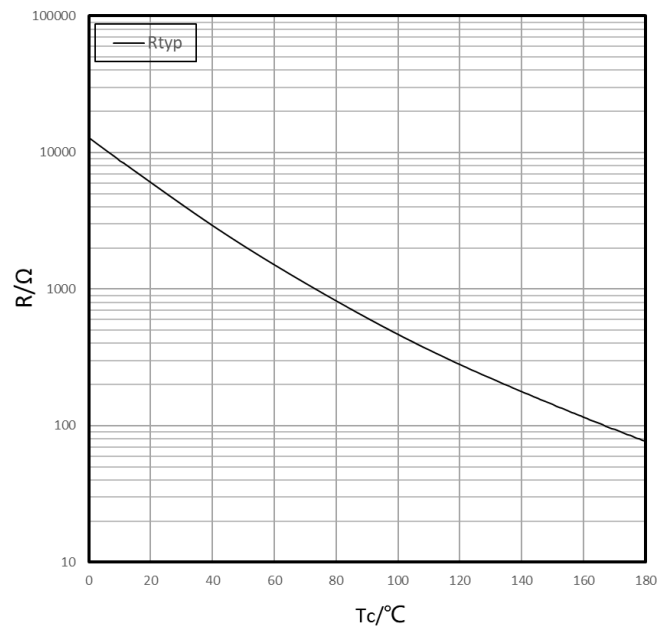

Internal Circuit / 内部电路

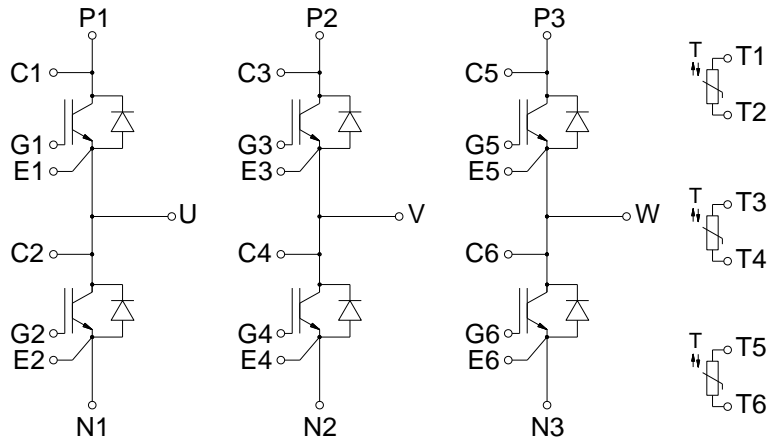

Package Dimension / 封装尺寸

Dimensions in Millimeters / 毫米为单位

