

A6 package: 750V 600A IGBT module

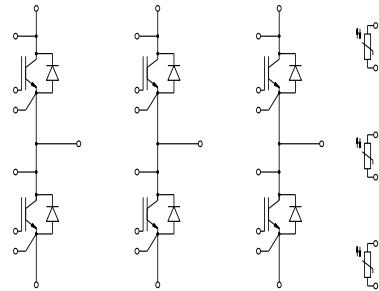
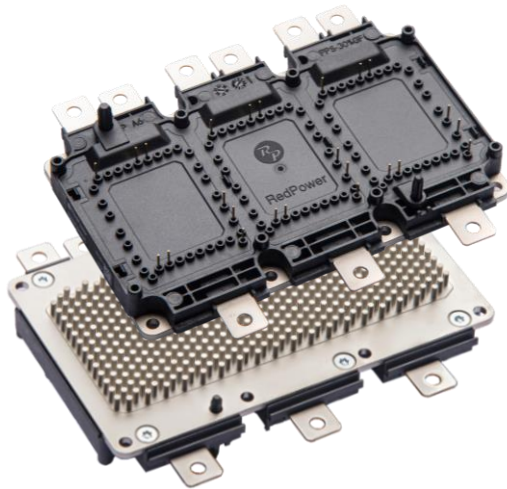

等效电路图
Equivalent Circuit Schematic

Features:

- 750V 600A, $V_{CE(sat)} = 1.35V @ 25^{\circ}C$
- Direct cooled PinFin Base Plate
- Micro pattern trench/FS Technology
- Low switching losses

产品特性:

- 750V 600A, $V_{CE(sat)} = 1.35V @ 25^{\circ}C$
- PinFin 直接液冷散热底板
- 微沟槽栅/场终止技术
- 低开关损耗

Typical Applications:

- Electric Vehicles
- Motor Drives

典型应用:

- 电动汽车
- 电机驱动

IGBT, Inverter / IGBT, 逆变部分
Maximum Rated Values / 最大标称参数

Collector-emitter Voltage 集电极-发射极电压	$T_{vj}=25^{\circ}\text{C}$	V_{CES}	750	V
Continuous DC collector current 集电极连续直流电流		$I_{C\text{ nom}}$	600	A
Continuous DC collector current 集电极连续直流电流	$T_F=80^{\circ}\text{C}$, $T_{vj\text{ max}}=175^{\circ}\text{C}$	I_C	460 ¹⁾	A
Repetitive Peak collector current 集电极可重复峰值电流	$t_p=1\text{ms}$	I_{CRM}	1200 ¹⁾	A
Gate-emitter peak voltage 门极-发射极峰值电压		V_{GES}	± 20	V

Characteristic Values / 性能参数

		min.	typ.	max.		
Collector-emitter saturation Voltage 集电极-发射极饱和压降	$I_C=450\text{A}$, $V_{GE}=15\text{V}$ $T_{vj}=25^{\circ}\text{C}$ $T_{vj}=150^{\circ}\text{C}$ $T_{vj}=175^{\circ}\text{C}$	$V_{CE\text{ sat}}$	1.30	1.55	V	
	$I_C=600\text{A}$, $V_{GE}=15\text{V}$ $T_{vj}=25^{\circ}\text{C}$ $T_{vj}=175^{\circ}\text{C}$		1.40	1.45		
Gate Threshold Voltage 门极阈值电压	$V_{CE}=V_{GE}$, $I_C=7.5\text{mA}$, $T_{vj}=25^{\circ}\text{C}$ $T_{vj}=175^{\circ}\text{C}$	$V_{GE\text{ th}}$	5.0	5.8 3.5	6.8	V
Internal Gate Resistor 内置门极电阻	$T_{vj}=25^{\circ}\text{C}$	$R_{G\text{ int}}$	0.37			Ω
Input Capacitance 输入电容	$V_{CE}=25\text{V}$, $V_{GE}=0\text{V}$, $f=100\text{kHz}$, $T_{vj}=25^{\circ}\text{C}$	C_{ies}	87.6			nF
Reverse Transfer Capacitance 反向传输电容	$V_{CE}=25\text{V}$, $V_{GE}=0\text{V}$, $f=100\text{kHz}$, $T_{vj}=25^{\circ}\text{C}$	C_{res}	1.2			nF
Gate Charge 门极电荷	$V_{GE}=-8\text{V}\sim 15\text{V}$	Q_G	tdb			μC
Collector-emitter Cutoff Current 集电极-发射极关断漏电流	$V_{CE}=750\text{V}$, $V_{GE}=0\text{V}$, $T_{vj}=25^{\circ}\text{C}$	I_{CES}			1	mA
Gate-emitter Leakage Current 门极-发射极漏电流	$V_{CE}=0\text{V}$, $V_{GE}=20\text{V}$, $T_{vj}=25^{\circ}\text{C}$	I_{GES}			400	nA
Turn-on Delay Time, Inductive Load 开通延迟时间, 感性负载	$I_C=450\text{A}$, $V_{CE}=400\text{V}$ $V_{GE}=-8\text{V}/15\text{V}$ $R_{Gon}=2.0\Omega$ $T_{vj}=25^{\circ}\text{C}$ $T_{vj}=150^{\circ}\text{C}$ $T_{vj}=175^{\circ}\text{C}$	t_{don}	156			ns
			180			
			180			
Rise Time, Inductive Load 上升时间, 感性负载	$I_C=450\text{A}$, $V_{CE}=400\text{V}$ $V_{GE}=-8\text{V}/15\text{V}$ $R_{Gon}=2.0\Omega$ $T_{vj}=25^{\circ}\text{C}$ $T_{vj}=150^{\circ}\text{C}$ $T_{vj}=175^{\circ}\text{C}$	t_r	67			ns
			77			
			81			
Turn-off Delay Time, Inductive Load 关断延迟时间, 感性负载	$I_C=450\text{A}$, $V_{CE}=400\text{V}$ $V_{GE}=-8\text{V}/15\text{V}$ $R_{Goff}=8.0\Omega$ $T_{vj}=25^{\circ}\text{C}$ $T_{vj}=150^{\circ}\text{C}$ $T_{vj}=175^{\circ}\text{C}$	t_{doff}	935			ns
			1035			
			1058			
Fall Time, Inductive Load 下降时间, 感性负载	$I_C=450\text{A}$, $V_{CE}=400\text{V}$ $V_{GE}=-8\text{V}/15\text{V}$ $R_{Goff}=8.0\Omega$ $T_{vj}=25^{\circ}\text{C}$ $T_{vj}=150^{\circ}\text{C}$ $T_{vj}=175^{\circ}\text{C}$	t_f	84			ns
			116			
			116			
Turn-on energy loss per pulse 开通损耗	$I_C=450\text{A}$, $V_{CE}=400\text{V}$ $V_{GE}=-8\text{V}/15\text{V}$, $R_{Gon}=2.0\Omega$ $di/dt(T_{vj}=25^{\circ}\text{C})=5400\text{A}/\mu\text{s}$ $di/dt(T_{vj}=150^{\circ}\text{C})=4700\text{A}/\mu\text{s}$ $T_{vj}=25^{\circ}\text{C}$ $T_{vj}=150^{\circ}\text{C}$ $T_{vj}=175^{\circ}\text{C}$	E_{on}	13.8			mJ
			19.9			
			21.8			
Turn-off energy loss per pulse 关断损耗	$I_C=450\text{A}$, $V_{CE}=400\text{V}$, $V_{GE}=-8\text{V}/15\text{V}$, $R_{Goff}=8.0\Omega$ $dv/dt(T_{vj}=25^{\circ}\text{C})=7100\text{V}/\mu\text{s}$ $dv/dt(T_{vj}=150^{\circ}\text{C})=4400\text{V}/\mu\text{s}$ $T_{vj}=25^{\circ}\text{C}$ $T_{vj}=150^{\circ}\text{C}$ $T_{vj}=175^{\circ}\text{C}$	E_{off}	26.5			mJ
			34.5			
			35.7			

¹⁾非测试值, 设计计算所得

SC Data 短路耐量	$V_{GE}=15V/-8V$, $V_{CC}=400V$, $V_{CEmax} \leq 750V$	$t_p \leq 6\mu s, T_{vj}=25^\circ C$ $t_p \leq 3\mu s, T_{vj}=175^\circ C$	I_{sc}		4400 3500		A
Thermal Resistance, Junction to Cooling fluid 结-散热器热阻	Per IGBT, $\Delta V/\Delta t=10dm^3/min$ $T_F=25^\circ C$		R_{thJF}		0.112		K/W
Temperature under switching conditions 工作温度			$T_{vj op}$	-40		150	$^\circ C$

Diode, Inverter / 二极管, 逆变部分

Maximum Rated Values / 最大标称参数

Repetitive peak reverse voltage 可重复反向峰值电压	$T_{vj}=25^\circ C$	V_{RRM}	750	V
Continuous DC Forward Current 可连续正向直流电流		I_F	600 ¹⁾	A
Repetitive Peak Forward Current 可重复正向峰值电流	$t_p=1ms$	I_{FRM}	1200 ¹⁾	A

Characteristic Values / 性能参数

		min.	typ.	max.		
Forward Voltage 正向通态压降	$I_F=450A, V_{GE}=0V$ $T_{vj}=25^\circ C$ $T_{vj}=150^\circ C$ $T_{vj}=175^\circ C$	V_F	1.44	1.75	V	
	$I_F=600A, V_{GE}=0V$ $T_{vj}=25^\circ C$ $T_{vj}=175^\circ C$		1.39			
Peak Reverse Recovery Current 反向恢复峰值电流	$I_F=450A, V_R=400V$ $-di_F/dt=4000A/\mu s(T_{vj}=150^\circ C)$ $V_{GE}=-8V$ $T_{vj}=25^\circ C$ $T_{vj}=150^\circ C$ $T_{vj}=175^\circ C$	I_{RM}	300		A	
			340			
Recovery Charge 反向恢复电荷	$I_F=450A, V_R=400V$ $-di_F/dt=4000A/\mu s(T_{vj}=150^\circ C)$ $V_{GE}=-8V$ $T_{vj}=25^\circ C$ $T_{vj}=150^\circ C$ $T_{vj}=175^\circ C$	Q_r	23.4		μC	
			42.9			
Reverse Recovery Energy 反向恢复损耗	$I_F=450A, V_R=400V$ $-di_F/dt=4000A/\mu s(T_{vj}=150^\circ C)$ $V_{GE}=-8V$ $T_{vj}=25^\circ C$ $T_{vj}=150^\circ C$ $T_{vj}=175^\circ C$	E_{rec}	5.5		mJ	
			11.3			
Thermal Resistance, Junction to Cooling fluid 结-散热器热阻	Per FRD, $\Delta V/\Delta t=10dm^3/min$ $T_F=25^\circ C$	R_{thJF}	0.156		K/W	
Temperature under switching conditions 工作温度			$T_{vj op}$	-40	150	$^\circ C$

¹⁾ 非测试值, 设计计算所得

NTC-Thermistor/ NTC-热敏电阻
Characteristic Values / 性能参数

		min.		typ.		max.	
Rated Resistance 标称电阻	$T_C=25^\circ\text{C}$	R_{25}		5.00			K Ω
Deviation of R100 R100 偏移值	$T_C=100^\circ\text{C}$, $R_{100}=493.3\Omega$	$\Delta R/R$	-5		5		%
Power Dissipation 功率耗散	$T_C=25^\circ\text{C}$	P_{25}			20		mW
B-Value B 值	$R_2=R_{25} \exp[B_{25/50}(1/T_2-1/(298.15\text{K}))]$	$B_{25/50}$		3375			K
B-Value B 值	$R_2=R_{25} \exp[B_{25/80}(1/T_2-1/(298.15\text{K}))]$	$B_{25/80}$		3414			K
B-Value B 值	$R_2=R_{25} \exp[B_{25/100}(1/T_2-1/(298.15\text{K}))]$	$B_{25/100}$		3436			K

Module / 模块

Isolation Test Voltage 绝缘测试电压	RMS, f=50Hz, t=1min	V_{ISOL}		3.0			KV
Material of Module Baseplate 模块底板材料				Cu+Ni ¹⁾			
Internal Isolation 内部绝缘				ZTA			
Creepage Distance 爬电距离	Terminal to heatsink Terminal to terminal			9.0 9.0			mm
Clearance 电气间隙	Terminal to heatsink Terminal to terminal			4.5 4.5			mm
Comparative Tracking Index 相对漏电起痕指数		CTI		200 ²⁾			

		min.		typ.		max.	
Stray Inductance Module 模块杂散电感		L_{SCE}		8.5			nH
Module Lead Resistance, Terminals-Chip 模块引脚电阻, 端子-芯片	$T_C=25^\circ\text{C}$, Per Switch	$R_{\text{CC}'+\text{EE}'}$		0.75			m Ω
Storage Temperature 贮存温度		T_{stg}	-40		125		$^\circ\text{C}$
Mounting Torque for Module Mounting 模块安装力矩	Screw M4 / M4 螺丝	M	1.8		2.2		Nm
Weight 重量		G		715			g

1) 铜底板表面镀镍

2) CTI 约为 200

Circuit Diagram / 曲线图

Output characteristic , Inverter IGBT (typical)

输出特性, 逆变IGBT (典型)

$I_c=f(V_{CE})$, $V_{GE}=15V$ (Inclusive $R_{CC'+EE'}$)

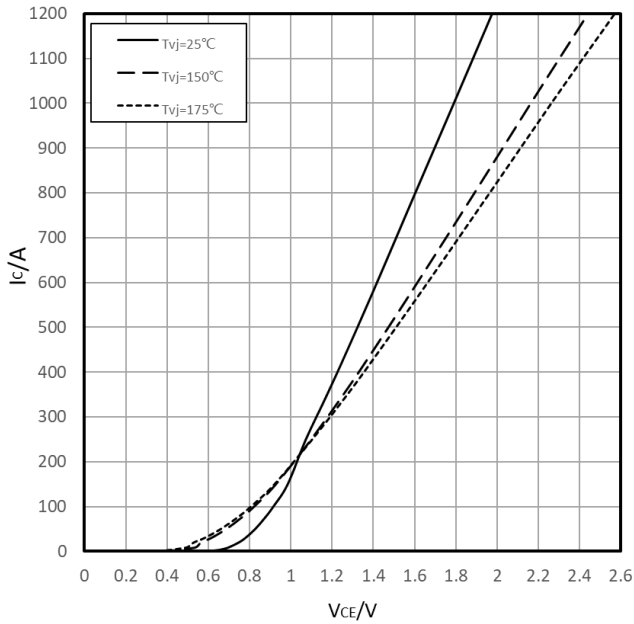

Output characteristic , Inverter IGBT (typical)

输出特性, 逆变IGBT (典型)

$I_c=f(V_{CE})$, $T_{vj}=150^\circ C$

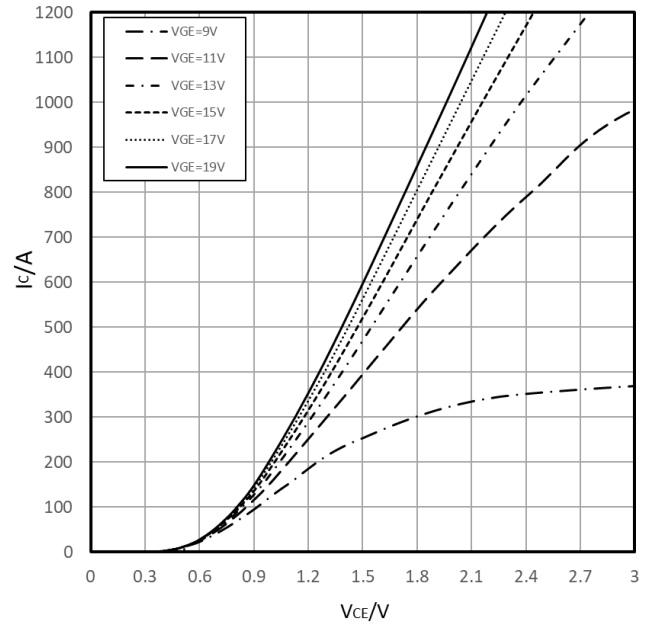

Transfer characteristic , Inverter IGBT (typical)

传输特性, 逆变IGBT (典型)

$I_c=f(V_{GE})$, $V_{CE}=20V$

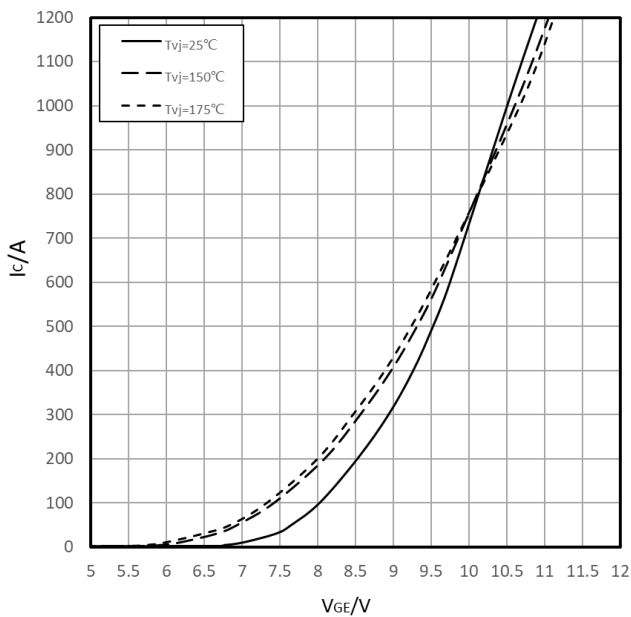

Switching losses , Inverter IGBT (typical)

开关损耗, 逆变IGBT (典型)

$E_{on}=f(I_c)$, $E_{off}=f(I_c)$

$V_{GE}=+15V/-8V$, $R_{gon}=2.0\Omega$, $R_{goff}=8.0\Omega$, $V_{CE}=400V$

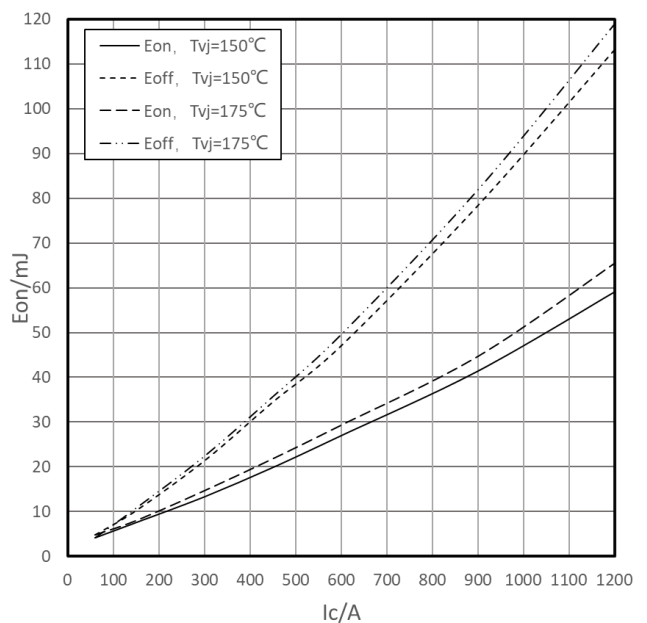

Switching losses , Inverter IGBT (typical)

开关损耗, 逆变IGBT (典型)

$E_{on}=f(R_g), E_{off}=f(R_g)$

$V_{GE}=+15V/-8V, I_C=450A, V_{CE}=400V$

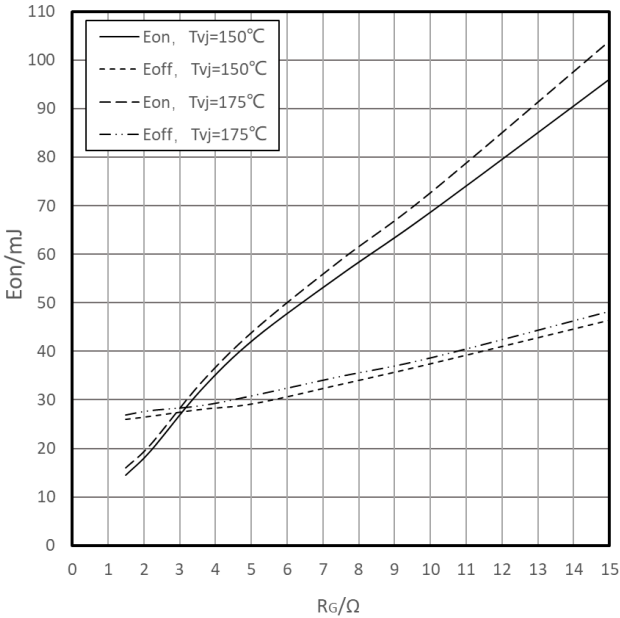

Transient thermal impedance IGBT, Inverter

瞬态热阻, 逆变IGBT

$Z_{th}=f(t)$

$\Delta V/\Delta t=10dm^3/min; T_f=25^\circ C; 100\% \text{ wafer}$

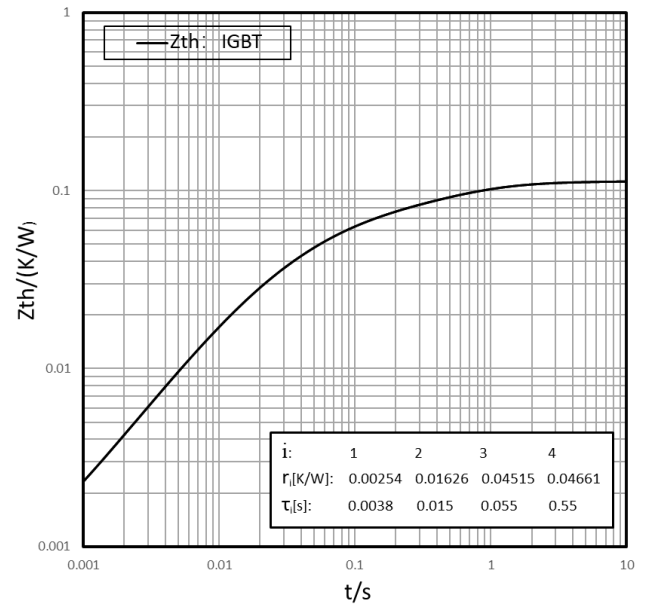

Reverse bias safe operating area , Inverter IGBT (RBSOA)

反偏安全工作区, 逆变IGBT (RBSOA)

$I_C=f(V_{CE}), V_{GE}=+15V/-8V, R_{goff}=8.0\Omega, T_{vj}=175^\circ C$

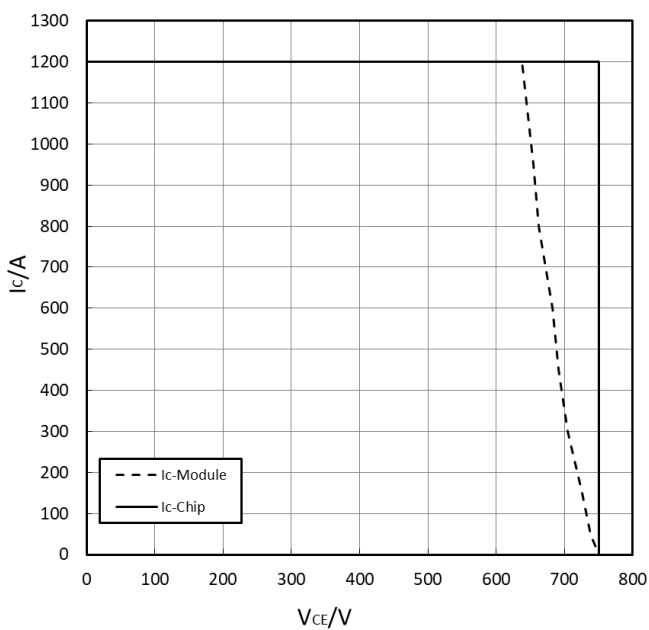

Forward characteristic , Inverter FRD (typical)

正向偏压特性, 逆变FRD (典型)

$I_F=f(V_F)$

(Inclusive $R_{CC'+EE'}$)

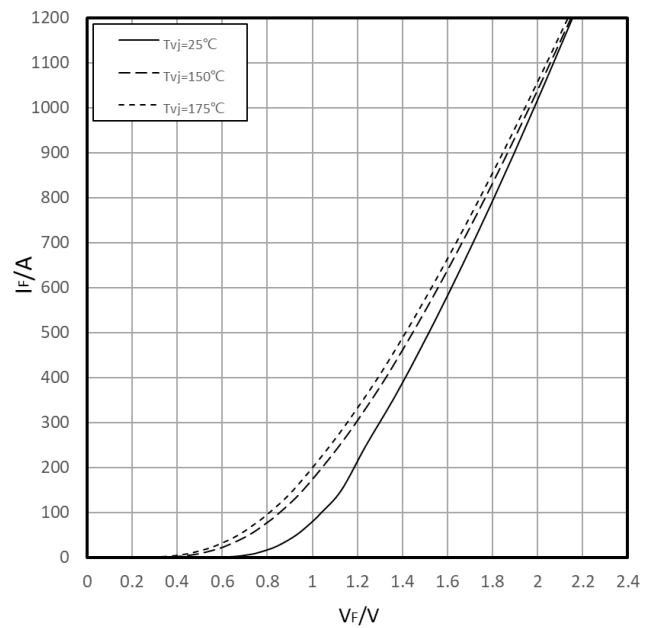

Switching losses , Inverter IGBT (typical)

开关损耗, 逆变FRD (典型)

$$E_{rec}=f(I_F), R_{gon}=2.0\Omega, V_{CE}=400V$$

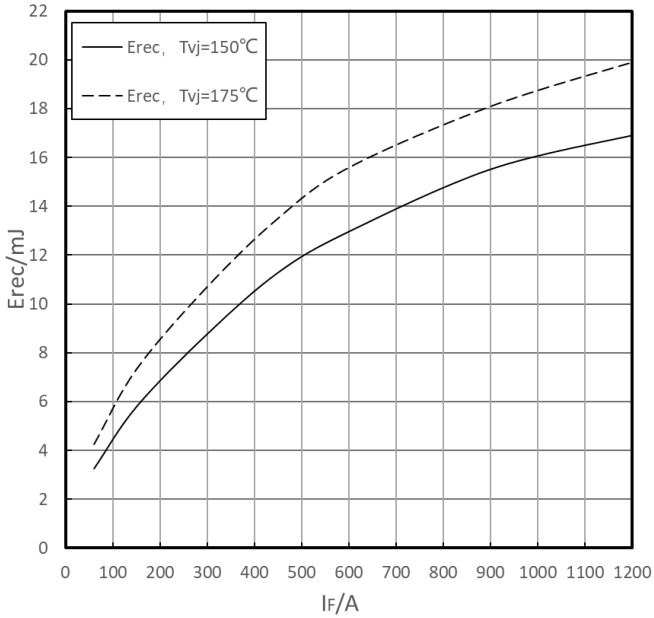
Switching losses , Inverter FRD (typical)

开关损耗, 逆变FRD (典型)

$$E_{rec}=f(R_G), I_F=450A, V_{CE}=400V$$

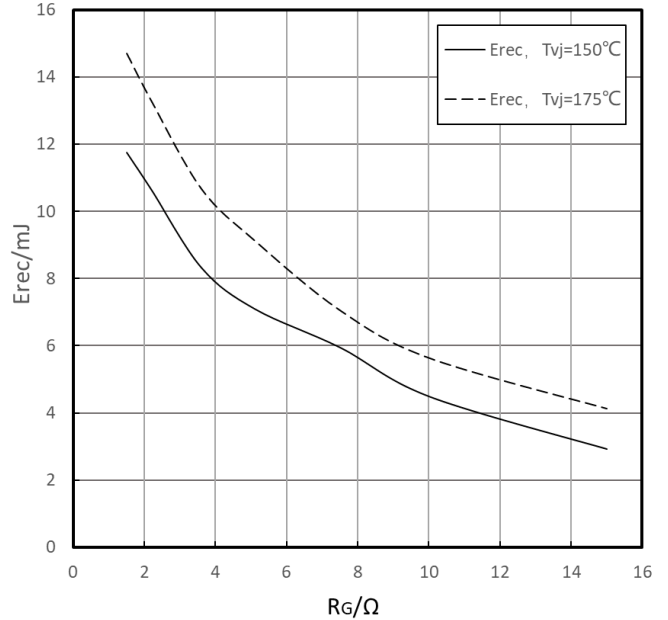
Transient thermal impedance FRD, Inverter

瞬态热阻, 逆变FRD

$$Z_{th}=f(t)$$

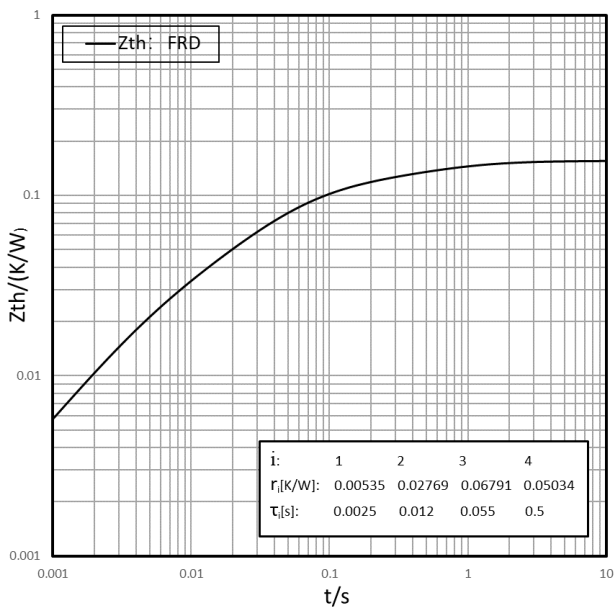
 $\Delta V/\Delta t=10dm^3/min; T_f=25^\circ C; 100\% wafer$

NTC-Thermistor-temperature characteristic

负温度系数热敏电阻 温度特性

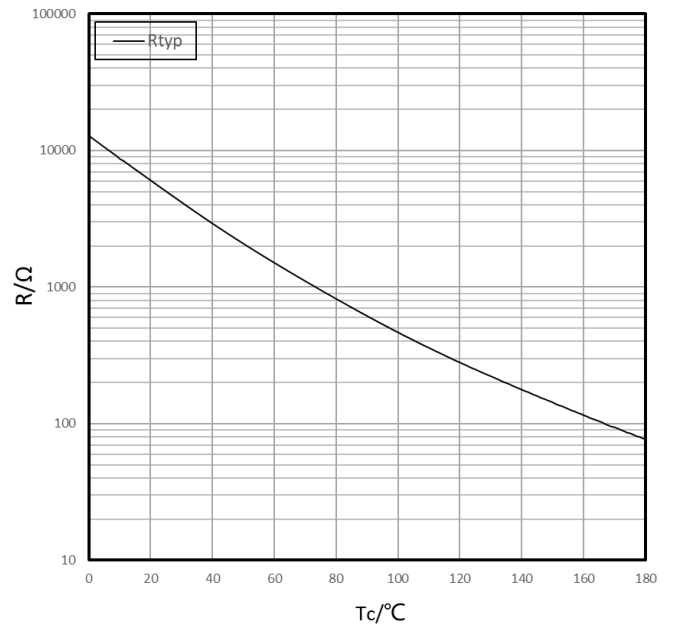
$$R=f(T)$$

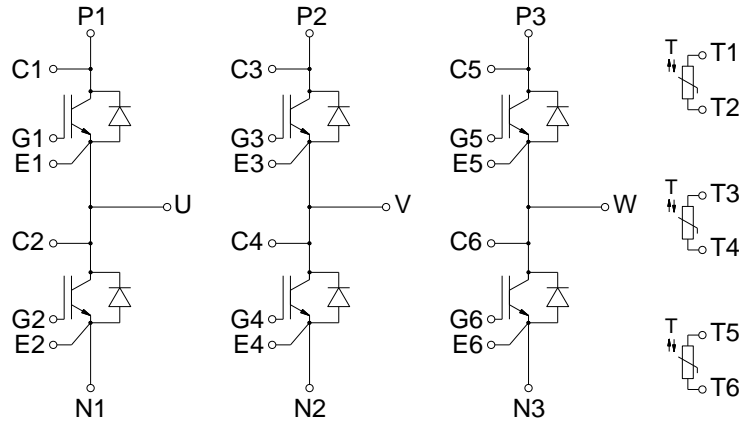

Internal Circuit / 内部电路



Package Dimension / 封装尺寸

Dimensions in Millimeters / 毫米为单位

